

Making cooking as much fun as eating

Please read this instruction manual. This will ensure that you make use of all the technical benefits the cooker has to offer.

It will provide you with important safety information. You will then be familiarised with the individual components of your new cooker. And we will show you how to make settings step by step. It is quite simple.

The tables list the settings and shelf positions for numerous well-known dishes. All these dishes are tested in our cooking studio.

In the unlikely event of a fault, look here for information on how to rectify minor faults yourself.

A detailed table of contents will help you to find your way around quickly.

Enjoy your meal!

Instruction manual

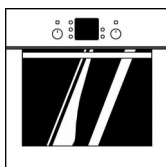

HBN 1315.0 B

en

5650 035 512

Table of contents

Important information	4
Before installation	4
Safety information	4
Reasons for damage	5
Your new cooker	6
The control panel	6
Function selector	7
Temperature selector	7
Control buttons and display panel	8
Push-in control knobs	8
Types of heating	8
Oven and shelving accessories	10
Cooling fan	13
Before using for the first time	14
Heating up the oven	14
Pre-cleaning the accessories	14
Setting the oven	15
Setting procedure	15
If the oven is to switch off automatically	16
If the oven is to switch on and off automatically	17
Time	18
Setting procedure	18
Timer	19
Setting procedure	19
Basic settings	20
Changing the basic settings	21

Table of contents

Childproof lock	22
Care and cleaning	22
Oven exterior	22
Oven	23
Cleaning the glass panels	25
Cleaning the rails	27
Seal	27
Accessories	27
Troubleshooting	28
Replacing the oven light	28
After-sales service	29
Packaging and old appliances	29
Tables and tips	30
Cakes and pastries	30
Baking tips	32
Meat, poultry, fish	33
Tips for roasting and grilling	35
Drying	36
Defrosting	36
Energy saving tips	37
Acrylamide in food	37
What can you do?	38
Test dishes	39

Important information

Read this instruction manual carefully. Only then will you be able to operate your cooker safely and correctly.

Please keep the instruction and installation manual in a safe place. Please pass on the instruction manual to the new owner if you sell the appliance.

Before installation

Transport damage

Check the appliance after unpacking it. Do not connect the appliance if it has been damaged in transport.

Electrical connection

The cooker may only be connected by an approved specialist. Losses resulting from damage caused by incorrect connection will invalidate warranty claims.

Safety information

Hot oven



This appliance is intended for domestic use only. Only use the cooker for food preparation.

Open the oven door carefully. Hot steam may escape. Never touch the internal surfaces of the oven or the heating elements. There is a risk of burning. Children must be kept at a safe distance from the appliance.

Never store combustible items in the oven. Risk of fire

Never clamp leads of electrical appliances in the hot oven door. The insulation on the leads could melt. There is a risk of short-circuiting.

Repairs



Incorrectly done repairs are dangerous. There is a risk of electrocution.

Repairs may only be carried out by after-sales service technicians who have been fully trained by BSH.

If there is a fault, switch off the oven fuse at the fuse box.

Call the after-sales service.

Reasons for damage

Baking tray, aluminium foil or dishes on the oven floor

Do not place the baking tray on the oven floor. Do not cover it with aluminium foil.

Do not place dishes on the oven floor.

This will cause heat accumulation. The baking and roasting times will no longer be correct and the enamel will be damaged.

Water in the oven

Never pour water directly into a hot oven. This could damage the enamel.

Fruit juice

When baking very moist fruit cakes, do not put too much on the baking sheet. Fruit juice dripping from the baking sheet leaves stains that cannot be removed.

It is recommended that you use the deeper universal pan.

Cooling with the oven door open

Only leave the oven to cool with the door closed. Do not allow anything to become trapped in the oven door. Even if you only leave the oven door open slightly, the fronts of adjacent units may become damaged over time.

Very dirty oven seal

If the oven seal is very dirty, the oven door will no longer close properly when the oven is in use. The fronts of adjacent units could be damaged. Keep the oven seal clean.

Using the oven door as a seat

Do not stand or sit on the oven door.

Your new cooker

Here you will learn more about your new oven. The control panel and its switches and indicators are explained here. The heating modes and the accessories included with your oven will be explained here.

The control panel

Details vary according to the appliance model.

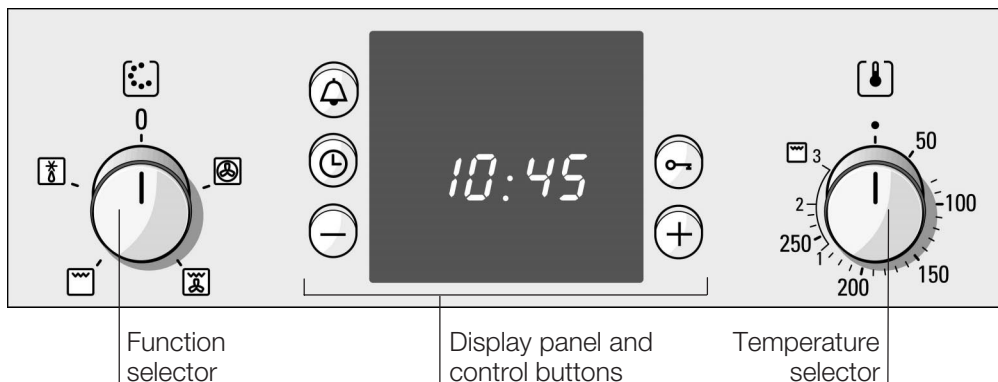



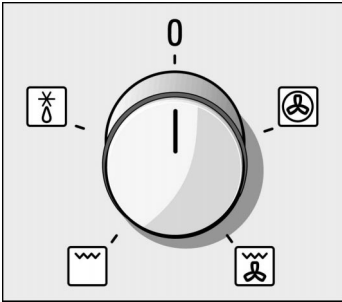

Function selector



Use the function selector to select the type of heating for the oven.

Settings

	3D hot air*
	Hot air grilling
	Radiant grill
	Defrosting

*Type of heating with energy efficiency class determined in accordance with EN50304.

The oven light switches on when you select a function.

Temperature selector

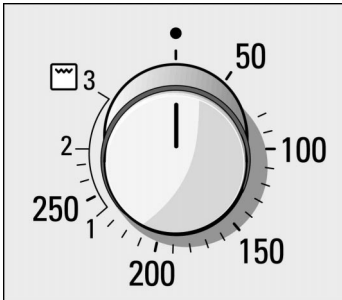

Use the temperature selector to set the temperature or grill setting.

Temperature

50 - 270	Temperature range in °C
----------	-------------------------

Grill

1	Low grill
2	Medium grill
3	High grill





The temperature symbol in the indicator comes on while the oven is heating up. It goes out during pauses in heating. The symbol does not come on for grilling and defrosting.

Grill settings

You can select a grill setting on the radiant grill  using the temperature selector.

Control buttons and display panel



Timer button 	Use this button to set the timer.
Clock button 	Use this button to set the time of day, the cooking time  and the completion time  .
Minus button -	Use this button to reduce the values set.
Plus button +	Use this button to increase the values set.
Key button 	Use this button to switch the childproof lock on and off.

The values set can be seen in the display panel.

Push-in control knobs

The control knobs can be pushed in. Simply press the control knob to release or lock it.

The function selector can be turned clockwise or anticlockwise, whereas the temperature selector can only be turned clockwise.

Types of heating

Different types of oven heating are available. You can therefore select the best method for cooking any dish.

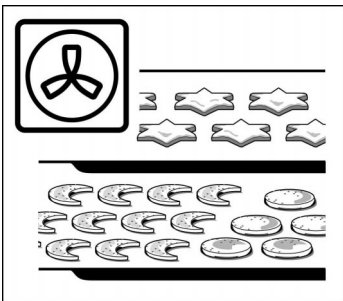

3D hot air

A fan in the rear panel distributes the heat from the ring heating element evenly inside the oven. Using 3D hot air, it is possible to bake cakes and pizza on two shelves, and biscuits and puff pastry on as many as three shelves at the same time. It is best to use this type of heating for puff pastry.

3D hot air is ideal for drying food.

Additional baking trays may be purchased at a later date from the after-sales service.

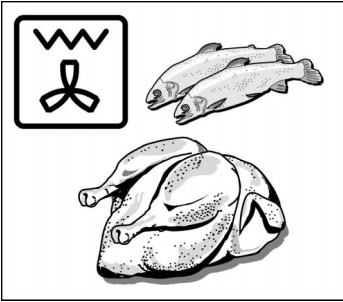

Hot air grilling

This type of heating involves the grill element and the fan switching on and off alternately. During the pause in heating, the fan circulates the heat generated by the grill around the food. This ensures that pieces of meat are crisped and brown on all sides. Large roasts, poultry and fish can also be cooked beautifully without using the rotary spit or preheating the oven.

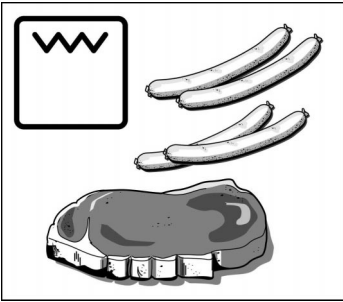

Radiant grilling

The entire area under the grill element becomes hot. This is ideal if you wish to cook steaks, sausages, fish or slices of toast.

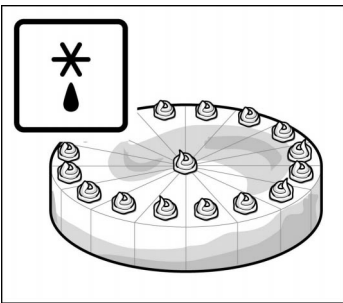

Defrosting

A fan in the rear panel circulates the air in the oven around the frozen food. Frozen pieces of meat, poultry, bread and cakes defrost evenly.

Oven and shelving accessories

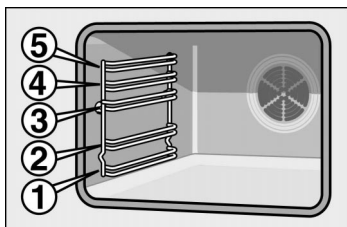

The shelf can be inserted at 5 different heights in the oven.

You can remove the shelf two thirds of the way without it tipping. This makes it easier to take food out of the oven.

Accessories

Accessories may be purchased at a later date from the after-sales service or from specialist shops. Please specify the HEZ number.

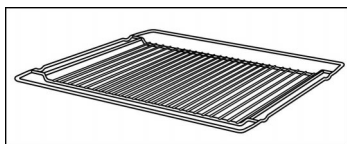

HEZ 334000 wire rack

For ovenware, cake tins, roasts, grilling and frozen meals.

Place the wire racks curved downwards .

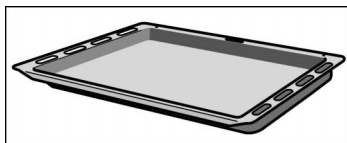

Universal pan HEZ 332000

for moist cakes, pastries, frozen food and large roasts. It can also be used to catch dripping fat when you are grilling directly on the wire grill.

Push the universal pan with the sloping edge facing towards the oven door.

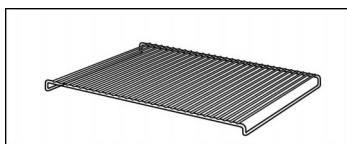

HEZ 324000 wire rack

for grilling. Always place the wire rack in the universal pan. Fat and meat juices are collected.

Optional accessory

Optional accessories may be purchased from the after-sales service or from specialist shops.

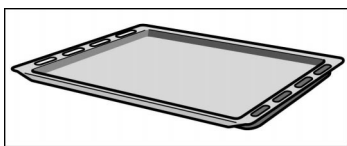

Enamel baking tray HEZ 331000

for cakes and biscuits.

Push the baking tray with the sloping edge facing towards the oven door.

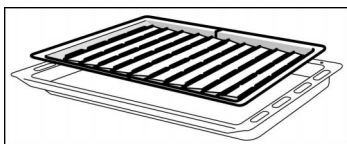

Grill pan HEZ 325000

Can be used for grilling instead of the wire grill or as a spray guard to protect the oven against dirt. Only use the grill pan in the universal pan.

To grill using the grill pan: use the same shelf height as for the wire grill.

Using the grill pan as a spray guard: insert the universal pan with the grill pan under the wire grill.

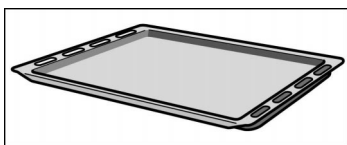

Enamel baking tray HEZ 331010 with non-stick coating

Cakes and biscuits can be removed from the baking tray more easily.

Push the baking tray with the sloping edge facing towards the oven door.

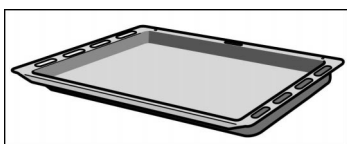

Universal pan HEZ 332010 with non-stick coating

Moist cakes, biscuits, frozen meals and large roast joints come away from the universal pan more easily.

Push the universal pan with the sloping edge facing towards the oven door.

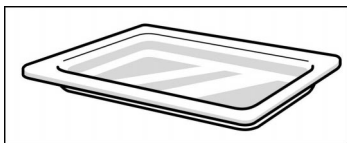

Glass pan HEZ 336000

A deep baking tray made from glass. Can also be used as a serving dish.

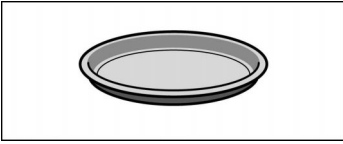

Pizza tray HEZ 317000

Ideal for pizza, frozen foods and large round cakes, for example. You can use the pizza tray instead of the universal pan. Place the tray on the wire grill. Observe the information provided in the tables.

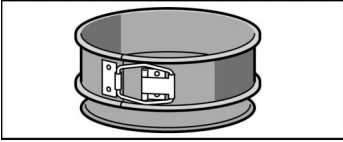

Baking tin HEZ 6001

You can bake especially moist cakes using the leak-proof baking tin. The extra wide rim prevents leakage and your cooker stays clean. The baking tin has a non-stick coating on the inside.

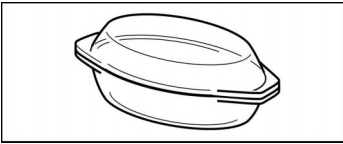

Glass roasting dish HMZ21 GB

for braised dishes and bakes that are cooked in the oven. It is especially suitable for the automatic roasting function.

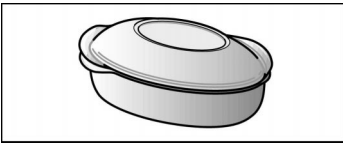

Metal roasting dish HEZ 6000

It is intended for use in the extended cooking zone of the glass ceramic hob. The dish is suitable for the sensor cooking system as well as for the automatic roasting function.

The roasting dish is enamel on the outside and has a non-stick coating on the inside.

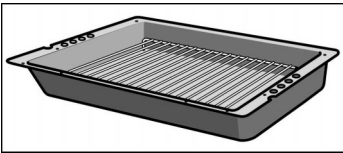

Profi extra-deep pan HEZ 333000

for cooking large quantities of food.

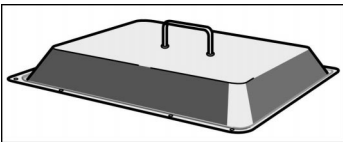

Lid for the Profi extra-deep pan HEZ 333001

Converts the Profi extra-deep pan into the Profi roasting dish.

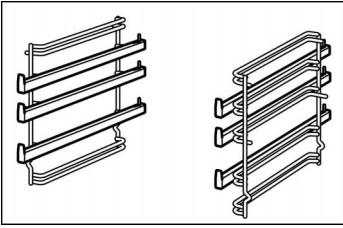

3 tier telescopic shelf HEZ 338305

The ledges at heights 2, 3 and 4 allow you to pull the shelf out further without it tipping.

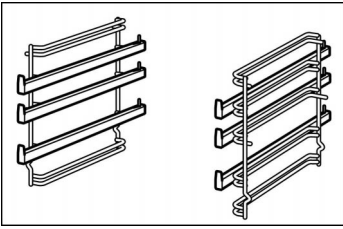

3 tier telescopic shelf HEZ 338300

The ledges at heights 2, 3 and 4 allow you to pull the shelf out further without it tipping.

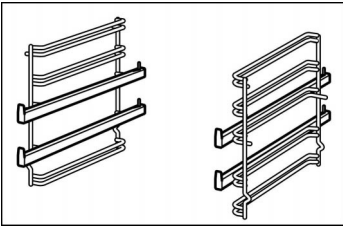

2 tier telescopic shelf HEZ 338200

The ledges at heights 2 and 3 allow you to pull the shelf out further without it tipping.

Cooling fan

The oven is fitted with a cooling fan. It switches itself on and off as necessary. The warm air escapes above the door.

Before using for the first time



This section will tell you everything you need to do before using the cooker for the first time.

Heat the oven and clean the accessories. Read the safety instructions in the “Important information” section.

Firstly, check to see if the  symbol and three zeros are flashing in the display.

If the  symbol and three zeros are flashing in the display

Set the time.

1. Press the  clock button.
12:00 appears and the  clock symbol flashes.
2. Set the time using the + or – button.

The time selected is adopted after a few seconds. The cooker is now ready for use.

Heating up the oven

Heat the empty oven with the door closed to remove the new oven smell.

Method

1. Set the function selector to .
2. Use the temperature selector to set the temperature to 240 °C.

Switch off the function selector after 60 minutes.

Pre-cleaning the accessories

Please wash the accessories thoroughly with soapy water and a cleaning cloth before using them.

Setting the oven

Switching off the oven manually

You have various options for setting the oven.

The oven switches off automatically

When your meal is ready, switch off the oven yourself.

The oven switches on and off automatically

You can leave the kitchen for a long period.

You can put your meal in the oven in the morning, for example, and set the oven so that your meal is ready at midday.

Tables and tips

The correct settings for many dishes can be found in the Tables and tips section.

Setting procedure

Example: 3D hot air ,
190 °C

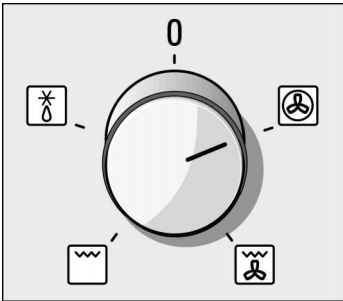

1. Select the desired type of heating using the function selector.

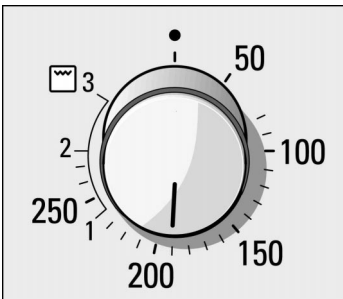

2. Use the temperature selector to set the temperature or grill setting.

Switching off

Switch off the function selector when the meal is ready.

Changing the setting

You may change the temperature or grill setting at any time.

If the oven is to switch off automatically

Perform the settings as described in items 1 and 2. Set the cooking time (duration) for your meal.

Example: Cooking time of 45 minutes

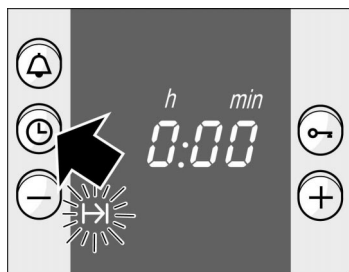

- 3.** Press the ⌚ clock button.
The cooking time symbol I→I will flash.



- 4.** Set the cooking time using the + or – button.
+ button default value = 30 minutes.
– button default value = 10 minutes.

The oven switches on after a few seconds.
The I→I symbol lights up in the display.

The cooking time has elapsed

A signal sounds. The oven switches off.
Press the ⌚ button twice and switch off the function selector.

Changing the setting

Press the ⌚ clock button. Change the cooking time using the + or – button.

Cancelling the setting

Press the ⌚ clock button. Press the – button until the display is at zero. Switch off the function selector.

Setting the cooking time when the clock time is hidden

If the oven is to switch on and off automatically

Example: Imagine – it's 10:45 a.m. The meal will take 45 minutes to cook and must be ready at 12:45 pm.

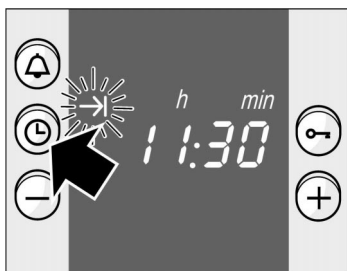



The cooking time has elapsed

Note

Press the  clock button twice and perform the setting as described in item 4.

Please remember that easily spoiled foods must not be allowed to remain in the oven for too long.

Perform the settings as described in items 1 to 4. The oven starts.

5. Press the  clock button until the  symbol flashes. In the display you will see the time when the meal will be ready.

6. Use the + button to set a later end time.

The setting is adopted after a few seconds. The display will show the end time until the oven switches on.

A signal sounds. The oven switches off. Press the  button twice and switch off the function selector.

You can change the setting while the symbol is flashing. The setting has been adopted if the symbol lights up permanently. You may change the waiting time that elapses before the setting is adopted. See the Basic settings section for more details.

Time

When the oven is first connected, or following a power cut, the ⌚ symbol and three zeros flash in the display. Set the time.

The function selector must be switched off.

Setting procedure

Example: 13:00

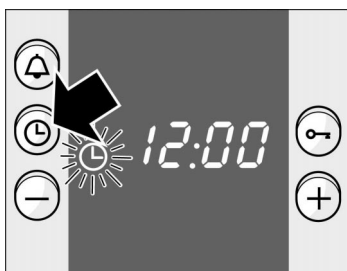

1. Press the ⌚ clock button.
12.00 appears in the display and the ⌚ symbol flashes.

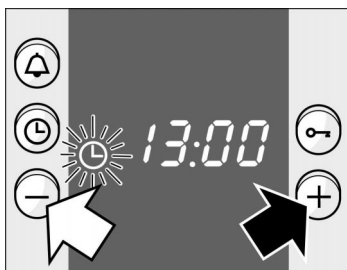

2. Set the time using the + or – button.

The time selected is adopted after a few seconds.

Changing the time e.g. from summer to winter time

Press the ⌚ clock button twice and change the time with the + or – button.

Hiding the time

You can hide the time. It will then only be visible when you are performing settings.
To do this, you must change the basic setting. See the Basic settings section.

Timer

You can use the timer as a kitchen timer. It operates independently of the oven.



The timer has a special signal. This means that you can tell whether the set timer period has elapsed or the cooking time is complete.

You can also set the timer if the childproof lock is active.

Setting procedure

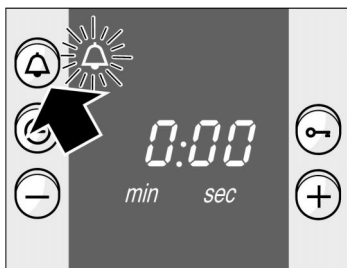
Example: 20 minutes



1. Press the  timer button.
The  symbol will flash.

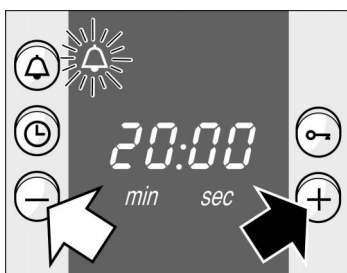

2. Set the timer period using the + or – button.
+ button default value = 10 minutes.
– button default value = 5 minutes.

The timer starts after a few seconds. The  symbol lights up in the display. The time counts down visibly.

The time has elapsed

A signal sounds. Press the  timer button. The timer display will go out.

Changing the timer period

Press the  timer button. Change the time using the + or – button.

Cancelling the setting

Press the  timer button. Press the – button until the display is at zero.

The timer and cooking time count down simultaneously

The symbols light up. The timer period counts down visibly in the display.

To call up the remaining cooking time **I→I**, end time **→I** or time **⌚**: Press the **⌚** clock button until the symbol in question flashes.

The value called up will then appear in the display for a few seconds.

Basic settings

Your oven has several basic settings. You may change the basic settings for time, the signal duration and the reset time for a setting.

Basic setting	Function	Change to
Time ⌚ <i>I</i> = Time in the foreground	Time display	Time ⌚ = Time hidden
Signal duration ⚡ 2 = approx. 2 mins.	Signal after cooking time or timer period has elapsed.	Signal duration <i>I</i> = approx. 10 seconds 3 = approx. 5 mins.
Reset time I→I 2 = medium	Waiting time between the adjustment increments before the setting is adopted.	Reset time <i>I</i> = short 3 = long

Changing the basic settings

Example: Hiding the time

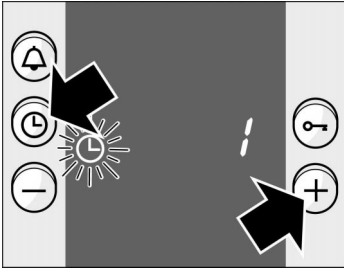

There must be no program set.

1. Press the ⌚ clock button and the + button at the same time until a *t* appears in the display. This is the basic setting for the time in the foreground.

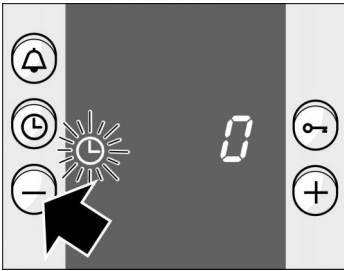

2. Change the basic setting using the + or – button.

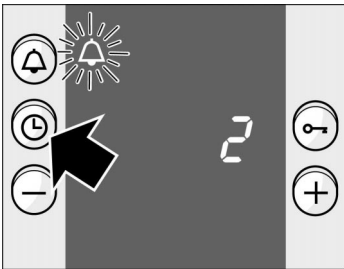

3. Confirm with the ⌚ clock button.

A 2 will appear in the display for the basic setting for the signal duration.

You do not wish to change all the basic settings

Correcting settings

Change the basic setting as described in step 2 and confirm with the ⌚ clock button. You can now change the reset time. To finish press the ⌚ clock button.



If you do not wish to change a basic setting, press the ⌚ clock button. The next basic setting will appear.

You may change your settings again at any time.

Childproof lock

The oven has a childproof lock to prevent children from switching it on accidentally.

Locking the oven

Press the  key button until the  symbol appears in the display. This will take approximately 4 seconds.

Unlocking

Press the  key button until the  goes out.

Notes

You can set the timer and the clock even when the oven is locked.

The childproof lock setting will be lost if there is a power cut.

Care and cleaning

Do not use high-pressure cleaners or steam jets.

Oven exterior

Wipe the oven with water and a little washing-up liquid. Dry it with a soft cloth.

Caustic or abrasive substances are not suitable. If any such substances come into contact with the frontage, wipe it off immediately with water.

Note

Slight differences in the colours on the appliance front are caused by the use of different materials, such as glass, plastic and metal.

Shadows on the door panel which resemble smears are reflections from the oven light.

Appliances with stainless steel fronts

Always remove any flecks of limescale, grease, cornflour and egg white immediately. Corrosion can form under such flecks.

Appliances with aluminium fronts

Use stainless steel care products. Follow the manufacturer's instructions. Try out the product on a small area first, before using on the whole surface.

Use a mild window-cleaning detergent. Wipe the area with a soft window cloth or a fluff-free micro-fibre cloth, using a horizontal action without applying pressure.

Aggressive cleaning products, scratchy sponges and rough cleaning cloths are not suitable.

Oven

Never use coarse scouring pads or cleaning sponges. Oven cleaner may only be used on enamelled oven surfaces.

For ease of cleaning

you can switch on the oven light and detach the oven door.

Switching on the oven light

Set the function selector to .

Detaching the oven door

The oven door can be easily detached.

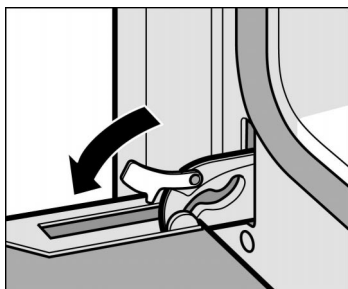

1. Open the oven door fully.
2. Move the two locking levers on the left and right-hand sides.

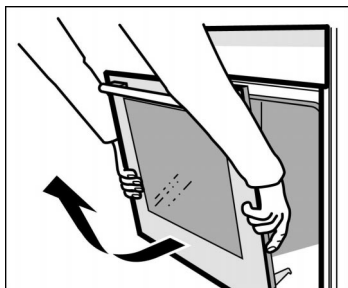



3. Half-close the oven door.
With both hands, grip the bottom of the door on the left and right-hand sides.
Close the door a little more and pull it out.

After cleaning, re-install the oven door, following the instructions in reverse order.

Self-cleaning surfaces in the oven

The rear panel and roof in the oven are coated with a highly porous ceramic layer. This coating absorbs and dispels splashes from baking and roasting while the oven is in operation. You will obtain a better result, the higher the temperature and the longer the oven is in operation.

If splashes are still visible even after repeated use, proceed as follows:

First clean the enamel surfaces in the oven. Then select 3D hot air  or top and bottom heating . Heat up the empty oven for approximately 2 hours at maximum temperature.

The ceramic coating is regenerated.

Brownish or whitish residues can be removed with water and a soft sponge.

Light discolouration of the coating does not affect automatic self-cleaning.

Important notes

Never use abrasive detergent. You will scratch or destroy the highly porous coating.

Never clean the ceramic coating with oven cleaner. If oven cleaner accidentally gets onto the rear panel or roof of the oven, remove it immediately with a sponge and plenty of water.

Cleaning the oven floor and the side walls

Use hot soapy water or a vinegar solution.

It is best to use oven cleaner if the oven is very dirty. Only use oven cleaner in a cold oven.

Never use oven cleaner on the self-cleaning surfaces of the oven.

Note:

Enamel is baked on at very high temperatures. This can cause some slight colour variation. This is normal and does not affect the function. Do not use coarse scouring pads or strong cleaning agents to remove such discolorations.

Cleaning the glass cover for the oven light

The edges of thin trays cannot be completely enamelled. As a result, these edges can be rough. Anti-corrosion protection is guaranteed.

It is best to clean the glass cover with washing-up liquid.

Cleaning the glass panels

Removal

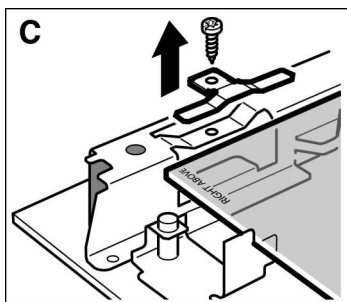
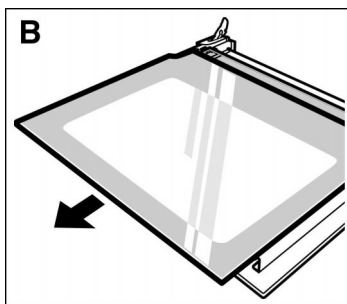
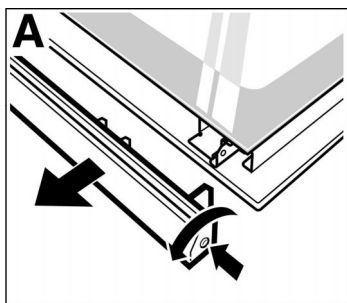

The glass panel on the oven door can be removed to assist in cleaning.

1. Remove the oven door and lay it down on a cloth with the handle underneath.
2. Unscrew the cover at the top of the oven door. To do this, undo the right and left-hand screws (Fig. A)
3. Slide out the top panel. (Fig. B)
4. Unscrew the clips on the right and left and remove them (Fig. C). Remove the panel.

Clean the glass panels with glass cleaner and a soft cloth.

Installation

Make sure that the message “Right above” is upside down at the bottom left of both panels.

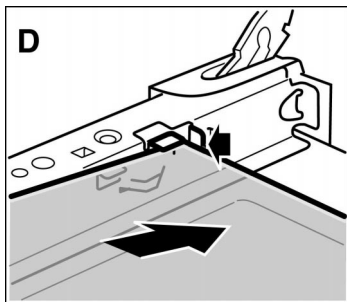

1. Push the glass panel back at an angle. (Fig. D)

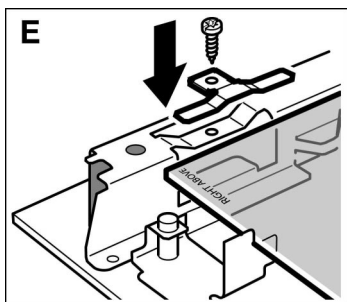

2. Fit the clips and screw them in again.

3. Push the top panel back in. Make sure that the smooth surface is facing outwards.

4. Replace the cover and screw it back on.

5. Refit the oven door.

The oven must not be used again until the panels have been correctly installed.

Cleaning the rails

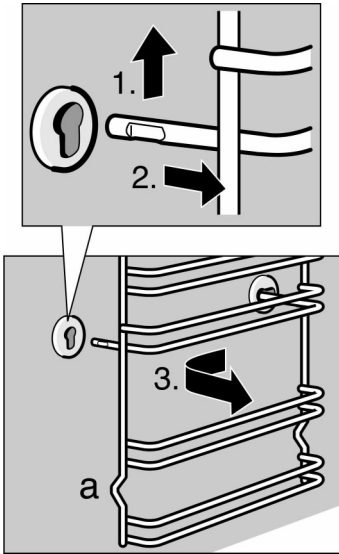

The rails can be removed for cleaning.

To unhook the rails:

1. Lift the rail at the front in an upwards direction
2. and unhook it.
3. Then pull the whole rail forward and take it out.

Clean the rails using either washing-up liquid and a sponge or a brush.

To hook rails back into position:

First insert the rail in the rear socket, push it back slightly and then hook it into the front socket.

The rails fit both the left and right sides. Recess (a) must always be at the bottom.

Seal

Clean the seal on the oven with washing-up liquid. Never use caustic or abrasive detergents.

Accessories

Immediately after use, soak the accessories in washing-up liquid. Food residues can then be easily removed with a brush or sponge.

Troubleshooting

Should a malfunction occur, it is often only due to a minor fault. Please read the following instructions before calling the after-sales service:

Problem	Possible cause	Comments/remedy
The oven does not work.	Blown fuse.	Look in the fuse box and check that the fuse is in working order.
The clock display flashes.	Power cut	Reset the time.

Repairs may only be carried out by fully trained after-sales service technicians.

Improper repairs may constitute serious hazards to the user.

Replacing the oven light

If the oven light fails, it must be replaced. 40 watt heat-resistant spare bulbs can be obtained from the after-sales service or specialist shops. Only use these bulbs.

Method



1. Switch off the oven fuse in the fuse box.
2. Place a tea towel in the cold oven to prevent damage.
3. Unscrew the glass cover by turning it anti-clockwise.
4. Replace the oven light with one of the same type.
5. Screw the glass cover back on.
6. Remove the tea towel and switch the fuse back on.

Replacing the glass cover

The glass cover on the oven light must be replaced if it is damaged. Replacement glass covers may be obtained from the after-sales service. To this end, please specify the E number and FD number of your appliance.

After-sales service

Our after-sales service is there for you if your oven needs repairing. You will find the address and telephone number of your nearest after-sales service centre in the phone book. The after-sales service centres listed will also be happy to advise you of a service point in your local area.

E number and FD number

Please quote the E number (product number) and the FD number (production number) of your appliance when contacting the after-sales service. The rating plate containing these numbers is found on the right, on the side of the oven door. You can make a note of these numbers in the space below to save time in the event of your appliance malfunctioning.

E no.	FD no.
-------	--------

After-sales service ☎

Packaging and old appliances

Disposing in an environmentally-responsible manner

Unpack the appliance and dispose of the packaging in an environmentally-responsible manner.



This appliance is labelled in accordance with the European Directive 2002/96/EC concerning used electrical and electronic appliances (waste electrical and electronic equipment – WEEE).

The guideline determines the framework for the return and recycling of used appliances as applicable.

Tables and tips

This table contains a selection of dishes and the optimum settings at which to cook them. You can find out which type of heating and temperature is best for your dish, which accessories to use, and at which oven level the dish should be inserted. You will find a variety of tips about ovenware and preparation, and a small troubleshooting section in case anything should go wrong.

Cakes and pastries

Baking on one level

If you are baking cakes on one level, you should use top/bottom heating . This will give the best results for your cakes.

Baking tins

It is best to use dark-coloured baking tins made of metal. Baking times are increased when light-coloured baking tins made of thin metal or glass dishes are used, and cakes do not brown so evenly.

Place the cake tin on the wire rack.

Tables



















The values in the table apply to dishes placed in a cold oven. This saves energy. Shorten the baking times indicated by 5 to 10 minutes if you have preheated the oven.

The tables show which type of heating is best for different cakes and bakes.

The temperature and cooking time you select depends on the quantity and type of pastry. This is why “ranges” are given in the tables. You should try to use a lower temperature setting to start with, since this allows more even browning. If necessary, use a higher temperature setting the next time.



More information can be found in the “Baking tips” section which follows the tables.







Baking on 1 level

Food	Dish	Shelf position	Cooking method	Temp. °C	Time, minutes
Victoria sandwich	20 cm tin	1		160	20-30
Light fruit cake	20 cm tin	2		160	80-90
Fruit crumble	Glass dish	3		160	35-45
Jam tarts*	12 hole bun tin	1		180	15-20
Yeast cookery* (f.ex. Pizza)	Universal pan	2		180	20-30
Tarts	20 cm plate or pie tin	3		190	40-50
Quiches	Glass dish	3		180	40-50
Swiss Roll*	Swiss roll tin	2		170	10-12
Rich Biscuits	Baking tray	1		170	15-20
Soufflés*	1,2 l soufflé dish	3		170	40-50
Pies	Pie dish	3		180	45-55
Rich fruit cake	Ø 23 cm round tin or 20 cm square cake tin	2		140	180-190
Meringues	universal pan	3		80	100-150
Pavlova	universal pan	3		150*+ 100	100-120
Jacket Potatoes	universal pan	2		160	60-70
Bread	loaf tin (900 g or 2 x 450 g)	1		200	25-35
Scones*	baking tray	1		180	15-20
Yorkshire Pudding*	12 hole bun tin	3		180	25-35

* Preheat oven

Baking on 2 or 3 levels

Food	Dish	Shelf position	Cooking method	Temp. °C	Time, minutes
Victoria sandwich	20 cm tin	1+3		160	35-40
Scones*	baking trays	1+3		170	20-30
Jacket potatoes	wire racks	1+3		160	60-75

Food	Dish	Shelf position	Cooking method	Temp. °C	Time, minutes
Biscuits	baking trays**	1+3		170	20-25
		2+3+5		160	25-30
Small Cakes*	baking trays**	1+3		160	25-35
Meringues	baking trays**	1+3		80	100-150
		2+3+5		80	100-150
Full meal	wire racks	1+4		180	75-85

* Preheat oven.

** When baking on two levels, use the universal pan provided, at shelf position three. When baking on three levels, use the universal pan at shelf position two. The universal pan can be removed earlier.

Additional baking trays and racks may be obtained as optional accessories from specialist shops.

Baking tips

You wish to cook to your own recipe.

Refer to the instructions in the tables for similar types of food.

How to check that a sponge cake is cooked properly.

Approximately 10 minutes before the end of the baking time given in the recipe, pierce the tallest point of the cake with a cocktail stick. The cake is done if the cocktail stick comes out clean.

The cake collapses.

Next time, use less liquid or decrease the oven temperature by 10 degrees. Observe the cooking times in the recipe.

The cake has risen in the centre but is lower at the edges.

Do not grease the sides of the springform cake tin. As soon as the cake is done, carefully loosen the cake around the edges using a knife.

The cake is too dark at the top.

Insert it at a lower level in the oven, select a lower temperature and cook the cake a little while longer.

The cake is too dry.

Use a toothpick to make small holes in the finished cake. Then drizzle fruit juice or alcohol over the top. Next time you should decrease the temperature by around 10 degrees and reduce the baking times.

The bread or cake (e.g. cheesecake) looks fine, but is soggy on the inside (soft, with watery areas).

Next time you should add a little less liquid and cook for a little longer at a lower temperature. Cakes with fruit topping: Precook the base first of all. Sprinkle with almonds or breadcrumbs and then place the topping over this. Please observe the recipe and the baking times.

The pastry is unevenly browned.

Select a slightly lower temperature to ensure that the pastry is baked more evenly. Baking paper that protrudes over the food can affect the air circulation. For this reason, always cut the baking paper to fit the baking tray.

The fruit cake is too light at the bottom. The fruit juice flows over.

Use the deeper universal pan next time.

You were baking on several levels. The food on the top baking tray is darker than that on the bottom baking tray.

Always use 3D hot air  when baking on several levels. Baking tray that are placed in the oven at the same time will not necessarily be ready at the same time.

Condensation is formed when baking cakes containing fresh fruit.

Baking may result in the formation of water vapour. It escapes above the door. The steam may settle and form water droplets on the control panel or on the fronts of adjacent units. This is a normal physical process.

Meat, poultry, fish

Ovenware

You may use any heat-resistant dishes. The universal pan is also suitable for larger roasts.

Always place the dishes in the centre of the wire grill.

Hot glass dishes should be placed on a dry kitchen towel after being removed from the oven. The glass could crack if placed on a cold or wet surface.

Advice on roasting

The roasting result depends on the type and quality of meat.

Add 2 to 3 soup spoons of liquid to lean meat, and 8 to 10 soup spoons of liquid to pot roasts, depending on the size.

Meat should be turned half way through the cooking time.

When the roast is ready, switch off the oven and leave the roast to stand for 10 minutes with the oven door closed. This allows the meat juices to distribute more favourably.

Advice on grilling

Always close the oven door when grilling.









If possible, use pieces of meat which are of the same thickness. They should be at least 2 to 3 cm thick. Such pieces will be browned evenly and stay juicy and soft in the middle. Only salt the steaks after they have been grilled.

Place the pieces of meat directly onto the wire grill. If you are grilling just one piece of meat, it will turn out best if you place it in the centre of the wire grill. You should also insert the universal pan at level 1. The meat juices are collected here and the oven is kept clean.

Turn the pieces of meat after two thirds of the cooking time indicated.





The grill element automatically switches itself off and back on again. This is normal. The number of times this happens depends on the grill setting you have selected.

Roasting

Food	Shelf position	Cooking method	Temp. °C	Cooking time min per 1 lb.
Beef rare	1		210-230	10+15
Beef medium	1		210-230	15+20
Beef well done	1		200-220	20+25
Beef fillet	1		200-220	15+20
Lamb medium	1		160-180	20+20
Lamb well done	1		160-180	25+25
Pork	1		190-210	30+30
Chicken, Duck, Goose and Turkey up to 5 kilo	1		140-180	20+20
Large Turkey	1		160-180	13+13

Food	Shelf position	Cooking method	Temp. °C	Cooking time min per 1 lb.
Chops and chicken joints	2		180-210	25

Grilling

Food	Shelf position	Cooking method	Grill setting	Cooking time min per 1 lb.
Meat steaks, bacon	5		2 or 3	12-22
Sausages and Fish fingers	4		3	15-20
Fish	4		2	10-20
Toast	5		3	4-5

Tips for roasting and grilling

The table does not contain information for the weight of the roast.

Select the next lowest weight from the instructions and extend the time.

How can you tell when the roast is ready?

Use a meat thermometer (available from specialist shops) or carry out a "spoon test". Press down on the roast with a spoon. If it feels firm, it is ready. If the spoon can be pressed in, it needs to be cooked for a little longer.

The roast is too dark and the crackling is partly burnt.

Check the shelf position and temperature.

The roast looks good, but the juices are burnt.

Next time, use a smaller roasting dish or add more liquid.

The roast looks good, but the juices are too clear and watery.





Next time, use a larger roasting dish or add less liquid.

Drying

Only use perfectly fresh fruit and vegetables, and wash them thoroughly.

Allow the food to drain well and dry it yourself.

Line the universal pan and wire rack with baking paper or greaseproof paper.

Meal	Level	Type of heating	Temperature in °C	Cooking time in hours
600 g apple rings	2 + 4		80	Approx. 5
800 g sliced pears	2 + 4		80	Approx. 8
1.5 kg prunes or plums	2 + 4		80	Approx. 8 - 10
200 g fresh herbs, washed	2 + 4		80	Approx. 1½

Note

Very moist fruit or vegetables should be turned several times. Once dried, remove the food from the paper immediately.

Defrosting

Remove the food from its packaging and place it in a suitable dish on the wire grill.

Please observe the instructions on the packaging.

The defrosting times depend on the type and amount of food.

Meal	Accessories	Level	Type of heating	Temperature in °C
Frozen foods* e.g. cream gateaux, cream cakes, cakes with chocolate or icing, fruit, chicken, sausages and meat, bread, rolls, pastries and other baked goods	Wire rack	2		The temperature selector remains switched off

* Cover frozen food with microwave foil. Place poultry onto the plate with the breast side down.

Energy saving tips

Only preheat the oven if it specifies in the recipe or in the table in the instruction manual that you should do so.

Use non-stick, black painted or enamelled tins. They absorb the heat especially well.

If you have several cakes to bake it is best to bake them one after the other. The oven is still warm. This shortens the baking time for the second cake. You can also put two baking tins in one after the other.

For long cooking times, the oven can be switched off 10 minutes before the end of the cooking time and the remaining heat can be used to finish the cooking.

Acrylamide in food

Experts are currently discussing how dangerous acrylamide in food can be. We have compiled this information sheet for you on the basis of current research.

Where does acrylamide come from?

Acrylamide in food does not come from external contamination. It is formed in the food itself during preparation - provided that the food contains carbohydrate and protein. Exactly how this happens has not yet been completely explained. However, it appears that the acrylamide content is strongly influenced by:

- high temperatures
- a low water content in food
- intensive browning of the food.

What sort of foods are affected?

Acrylamide forms mostly in grain and potato products that are prepared at high temperatures, e.g.:

- crisps, chips,
- toast, rolls, bread,
- baked goods made from shortcrust pastry (speciality biscuits and cakes).

What can you do?

You can avoid high levels of acrylamide when baking, frying and grilling.

The following recommendations were published by AID¹ and BMVEL² to help you minimise acrylamide levels:

In general

Keep cooking times as short as possible.

“Brown rather than burn” - cook food only until it is golden brown.

The larger and thicker the food is, the less acrylamide it contains.

Baking

Set the temperature to a maximum of 200 °C when using the top/bottom heating setting, and to a maximum of 180 °C for the 3D hot air setting.

Cookies: Set the temperature to a maximum of 190 °C when using the top/bottom heating setting, and to a maximum of 170 °C for the 3D hot air setting. The presence of egg or egg yolk in a recipe reduces the formation of acrylamide.

Spread oven chips evenly over the baking sheet in one layer where possible. To prevent the food from drying out quickly, place at least 400 g on each baking sheet.





¹ AID “Acrylamide” information leaflet, published by AID (German Evaluation and Information Service for Nutrition, Agriculture and Forestry) and BMVEL (German Federal Ministry for Consumer Protection, Food and Agriculture), as at 12/02, Internet: <http://www.aid.de>.

² BMVEL press release 365, as at 4.12.2002, Internet: <http://www.verbraucherministerium.de>

Test dishes



referring to EN 60350.

Baking

Food	Dish and notes	Shelf position	Cooking method	Temp. °C	Cooking time min
Small Cakes (preheat oven)	baking tray	3		150-170	20-30
	baking tray + universal pan*	1+3		150-170	25-35
Fatless sponge cake	baking tin (dark coated)	1		140-160	30-40
Apple pie	2 wire racks + 2 tinplates springform cake tins Ø 20 cm	2+4, placed diagonally		190-210	70-80
	universal pan + 2 tinplates springform cake tins Ø 20 cm	1 in the centre alongside one another		190-210	70-80

* When baking on two levels, use the universal pan provided, at shelf position three.

Grilling

Food	Dish and notes	Shelf position	Cooking method	Grill setting	Cooking time min
White bread (preheat oven 10 min)	wire rack	5		Setting 3	1-2
Beefburger*	wire rack	4		Setting 3	25-30

* Turn the burgers over after 12-15 min. Insert the universal pan at level 1.

